

### MIRAI COLD 10

**MIRAI Cold 10** - operates in a open cycle configuration supplying air directly to the chamber. Open cycle machines are most used for applications such as:

- » **biological/pharma storage** » **whole-body cryotherapy**
- » **metal hardening** » **climate testing**
- » **food storage**

### SNOW CATCHER

Our open cycle machines are supplied with a Snow Catcher. A revolutionary **Humidity Extraction Device (HED)** which traps the humidity from the air in the chamber and extracts it mechanically. There is no need for evaporators and fans inside the chamber. Defrost procedures are not required with HED solution.

### CERTIFICATION

MIRAI Cold 10 is CE certified by respected European certification organization. CE certification covers:

- » **Low voltage directive** (LVD) 2014/35/EU
- » **Machinery directive** (MD) 2006/42/EC
- » **Pressure equipment directive** (PED) 2014/68/EU, Module A2
- » **Electromagnetic compatibility directive** (EMC) Directive 2014/30/EU

### AIR-CYCLE TECHNOLOGY

The technology is based on the heating capability of air (R729) during compression and cooling down during the expansion process. Repetition of compression and expansion cycles allows to reach and maintain ultra-low temperatures down to -160 °C.

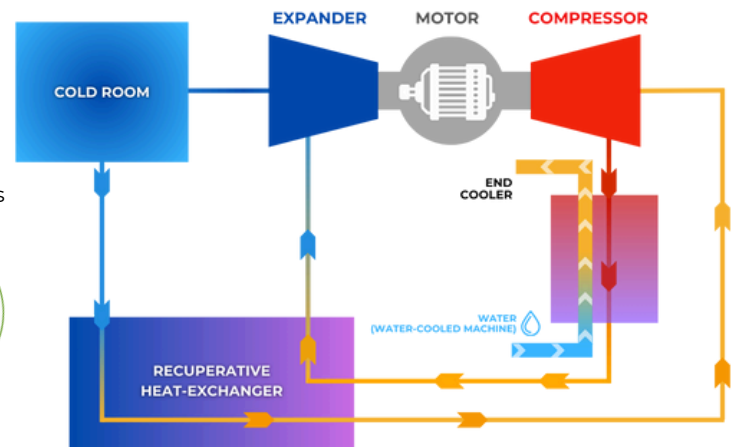

© 2024 MIRAI Intex®, Revision 11/2024

### MAIN ADVANTAGES

- |   |  |  |
|---|--|--|
| <ul style="list-style-type: none"> <li> <b>OPERATING STABILITY</b> <ul style="list-style-type: none"> <li>· Stable continuous operation</li> <li>· Stable loads on cooling water and power grid</li> </ul> </li> <li> <b>REDUCED OPERATING COSTS</b> <ul style="list-style-type: none"> <li>· Long equipment lifecycle</li> <li>· Low maintenance</li> </ul> </li> <li> <b>AIR AS REFRIGERANT</b> <ul style="list-style-type: none"> <li>· 0 GWP, 0 ODP, and 0 TFA</li> <li>· Environmentally friendly</li> <li>· Refrigerant free of charge</li> </ul> </li> </ul> | <ul style="list-style-type: none"> <li> <b>TEMPERATURE STABILITY</b> <ul style="list-style-type: none"> <li>· Frequency inverter allows maintaining 0.5 K accuracy</li> </ul> </li> <li> <b>NO VIBRATION OR NOISE</b> <ul style="list-style-type: none"> <li>· Turbo-compressor design reduces noise and vibrations</li> </ul> </li> <li> <b>OIL-FREE</b> <ul style="list-style-type: none"> <li>· No oil in the system</li> <li>· Reduced maintenance costs</li> <li>· Reduced operation costs</li> </ul> </li> </ul> | <ul style="list-style-type: none"> <li> <b>ENERGY EFFICIENCY</b> <ul style="list-style-type: none"> <li>· Energy recovery</li> <li>· Automatic RPM control</li> </ul> </li> <li> <b>SAFE SOLUTION</b> <ul style="list-style-type: none"> <li>· No chemically active substances</li> <li>· No risk of fire or explosion</li> </ul> </li> <li> <b>LEGISLATIVE COMPLIANCE</b> <ul style="list-style-type: none"> <li>· Compliance with all international standards / regulations</li> <li>· No special safety requirements</li> </ul> </li> </ul> |
|---|--|--|

### COOLING CAPACITY

Cooling capacity of **MC 10 O/W**, at an inlet water temperature of 6°C and 30°C

*Data may differ depending on application design and specific operation conditions unable to predict.*

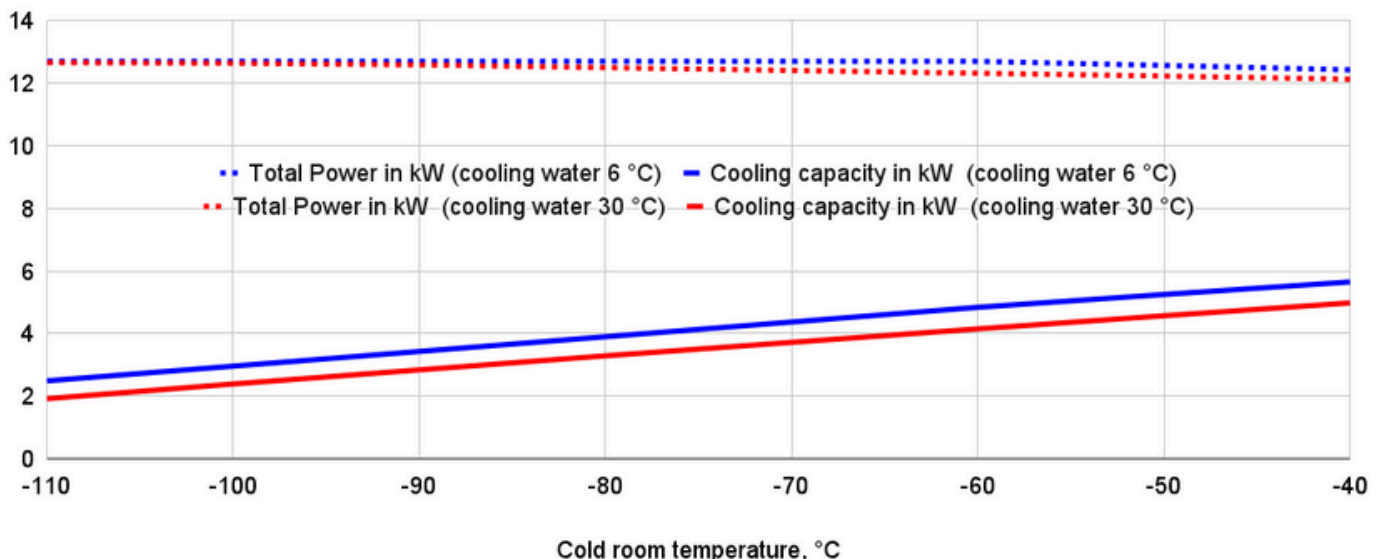

### TECHNICAL SPECIFICATIONS

#### AIR CYCLE

TEMPERATURE RANGE		From -40 °C to -110 °C		
REFRIGERATION CAPACITY AT SET POINT*		-40°C	-70°C	-110°C
		5.65 kW	4.37 kW	2.49 kW
REFRIGERANT		Natural Air (R729)		
COMPRESSOR		Mirai Turbo-Compressor (water-cooled)		
ROTATION SPEED		Maximum 85 000 rpm		
RATED MOTOR POWER		10.5 kW		
COMPRESSOR OUTLET PRESSURE		Maximum 1.2 bar		
AIR SUPPLY TO THE COOLING CHAMBER		From 250 to 600 kg/h		
HYDRAULIC RESISTANCE OF ALL EQUIPMENT INTEGRATED BETWEEN	<b>RM</b> OUTLET AND COLD ROOM	300 Pa		
	COLD ROOM AND <b>RM</b> INLET	50 Pa		

#### COOLING WATER

COOLING WATER MASS FLOW RATE	From 1 000 to 4 000 kg/h
PRESSURE DROP ON WATER SIDE BETWEEN <b>RM</b> INLET AND OUTLET, MAXIMUM	0.8 bar
ALLOWED PRESSURE ON WATER INLET	Maximum 4 bar
COOLING WATER TEMPERATURE RANGE	From +6 °C to +30 °C**
CONNECTION SIZE COOLING WATER in   out	DN15   DN15

#### GENERAL TECHNICAL SPECIFICATION

ACOUSTIC SOUND PRESSURE, AT A DISTANCE OF 1 M FROM <b>RM</b>	Maximum 70 dB
CONTROL PANEL	7" color touch screen display, data record, temperature control
CONTROL SYSTEM	KEB system compatible with digital communication protocols ProfiNET, EtherCAT, EtherNET/IP, and Powerlink
SAFETY PROTECTION	High pressure protection, water supply cut-off protection, over-current protection, phase failure protection, high temperature protection, sensor failure protection
PIPING MATERIAL	Stainless steel
CASE MATERIAL	Steel
MACHINE DIMENSIONS (L x W x H)	103 x 133x 179 cm(± 1.5 cm)
MACHINE WEIGHT	800 kg (± 50 kg)
TECHNICAL REQUIREMENTS FOR OPERATION	Ambient temperature limits in mechanical room +5 °C to +35 °C or canopy in case of external installation
OPTIONAL ACCESSORIES	Remote monitoring system

#### POWER SUPPLY

STANDARD POWER SUPPLY ***	~3 PE+N, 400 V, 50 Hz
NOMINAL CURRENT	31 A
MAXIMUM CURRENT	63 A

\* At set temp point and cooling water temp. +6 °C  
 \*\* For possibility of other cooling water range, contact MIRAI  
 \*\*\* For possibility of other power supply options, contact MIRAI  
**RM** - Refrigeration machine

Performance is nominal and individual units may vary. The efficiency of each refrigeration unit will depend on the specific operating conditions.

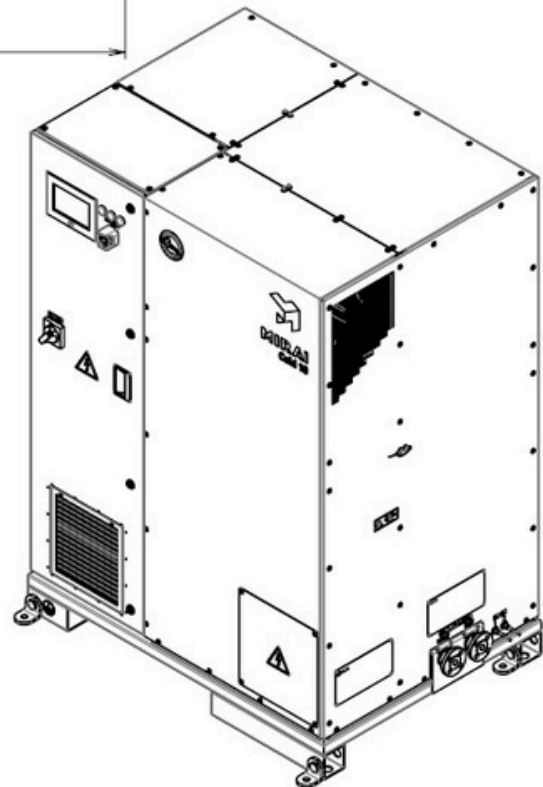
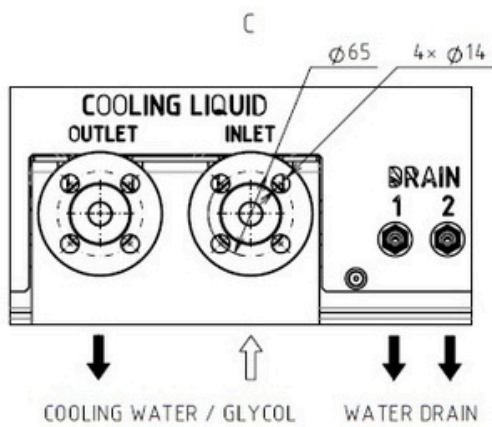
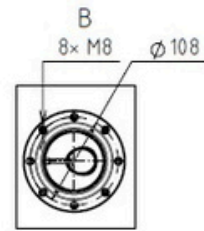
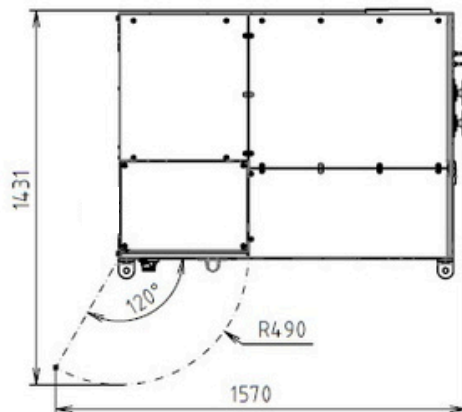
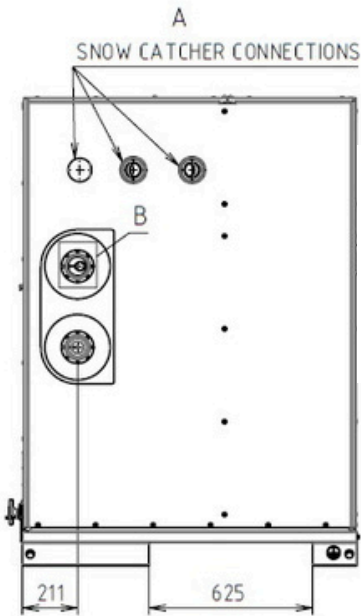
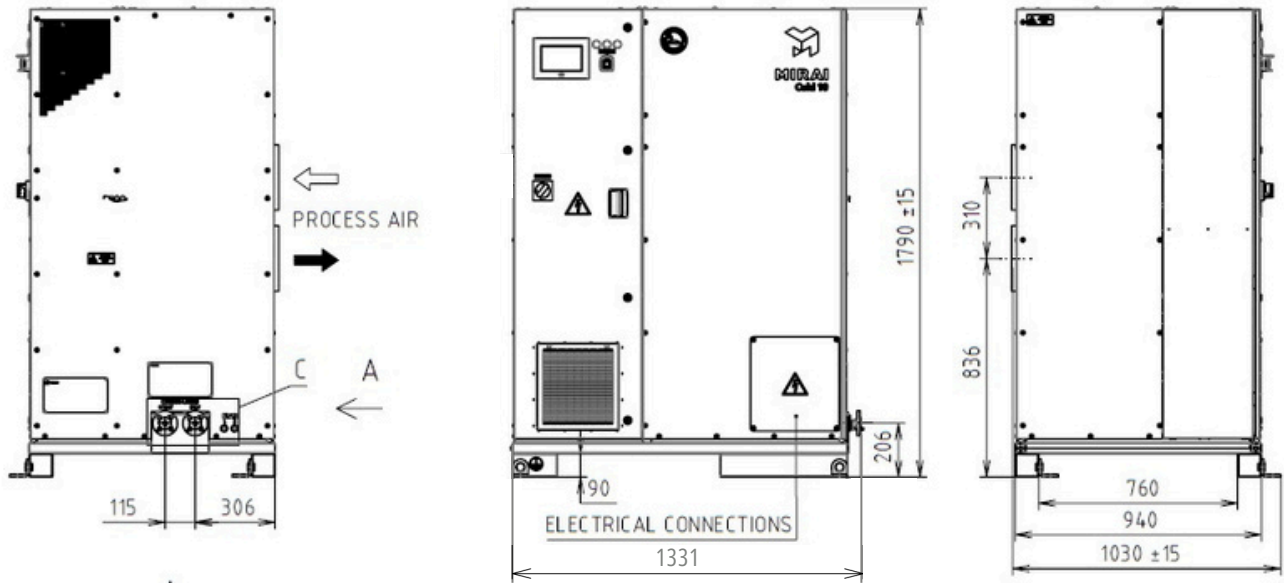
**DIMENSIONS**

**DIMENSIONS OF SNOW CATCHER WITH SNOW TRAY**
